

Travan NS

Not for the Desktop Anymore

Jane Hassler

Imation Corporation

1 Imation Place

Oakdale, MN 55128

jahassler@imation.com

Phone: 612-704-5360

Fax: 612-704-6111

21 January 1998



THIC Presentation

**Travan NS: We're
not just for the
Desktop, anymore**

January 21, 1998



IMATION: Who are We?

- ◆ **eye-may-tion?**
- ◆ **im-i-ta-tion?**
- ◆ **3M?**
- ◆ **Imaging, Imagination, Information=
eh-may-tion**



Look for the NS Shield



The seal of Imation's
commitment to Travan
Technology leadership.



What is “NS”

- ◆ Stands for “NETWORK SERIES”
- ◆ A HARDWARE statement, differentiating those Travan technology drives with features for the Entry Level SERVER from Travan technology drives with features for the Professional Desktop and Workstation



What are those “Network Series” features?

- ◆ Hardware compression, standardized with the ALDC compression chip
- ◆ Read while write capabilities



Travan™ Migration Path

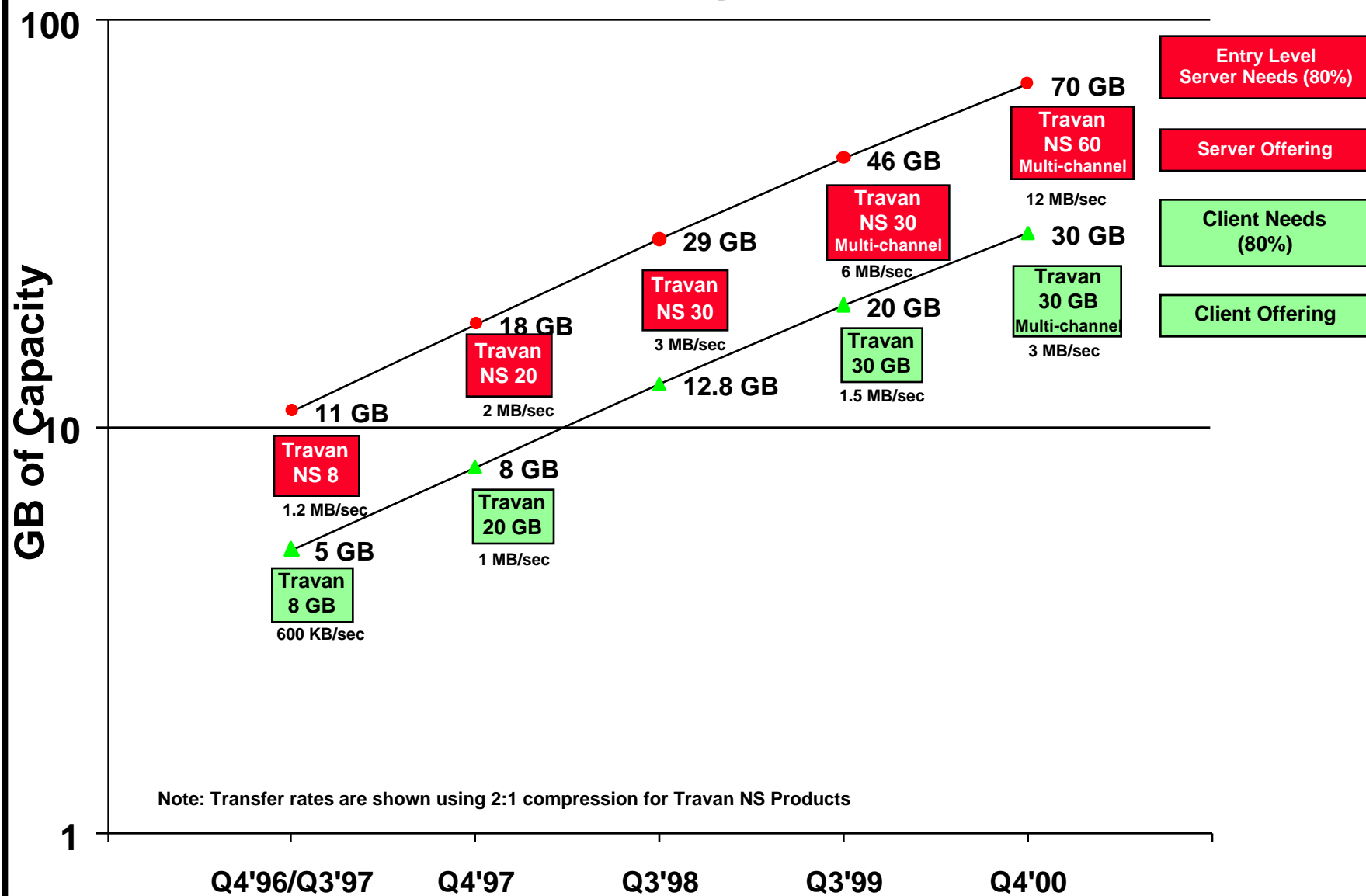

Travan Nomenclature

Original/Current

TR-1/Travan 1
TR-3/Travan 3
TR-3+
TR-4-
TR-4/Travan 4
TR-5/Travan 5

New “DeskTop”

End of life
Travan 3GB
Imation Ditto 5GB
Travan 5GB
*Travan 8GB**
*Travan 20GB**

New “NS”

Travan NS 8
Travan NS 20

***Travan 8 GB and Travan 20 GB Are Becoming the DRIVES’
Nomenclature**

**ONE “Travan NS” CARTRIDGE WILL SERVE BOTH DRIVE
Formats**



**Is this all marketing hoo-hah,
or is there some reason you
should care?**



- ◆ **Based on the Wintel computing model, the Entry Level Server today, and that of tomorrow, is a significantly more affordable, and therefore, more prevalent piece of hardware than it was just two years ago.**



Servers Unite!

- ◆ **Trends in the industry to strip down desktop PC performance and feed information through the server -**
- ◆ **The death of the PC and the \$999 price point**
- ◆ **The Network Computer**



Industry Driving Factors

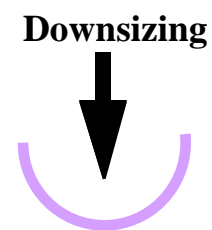
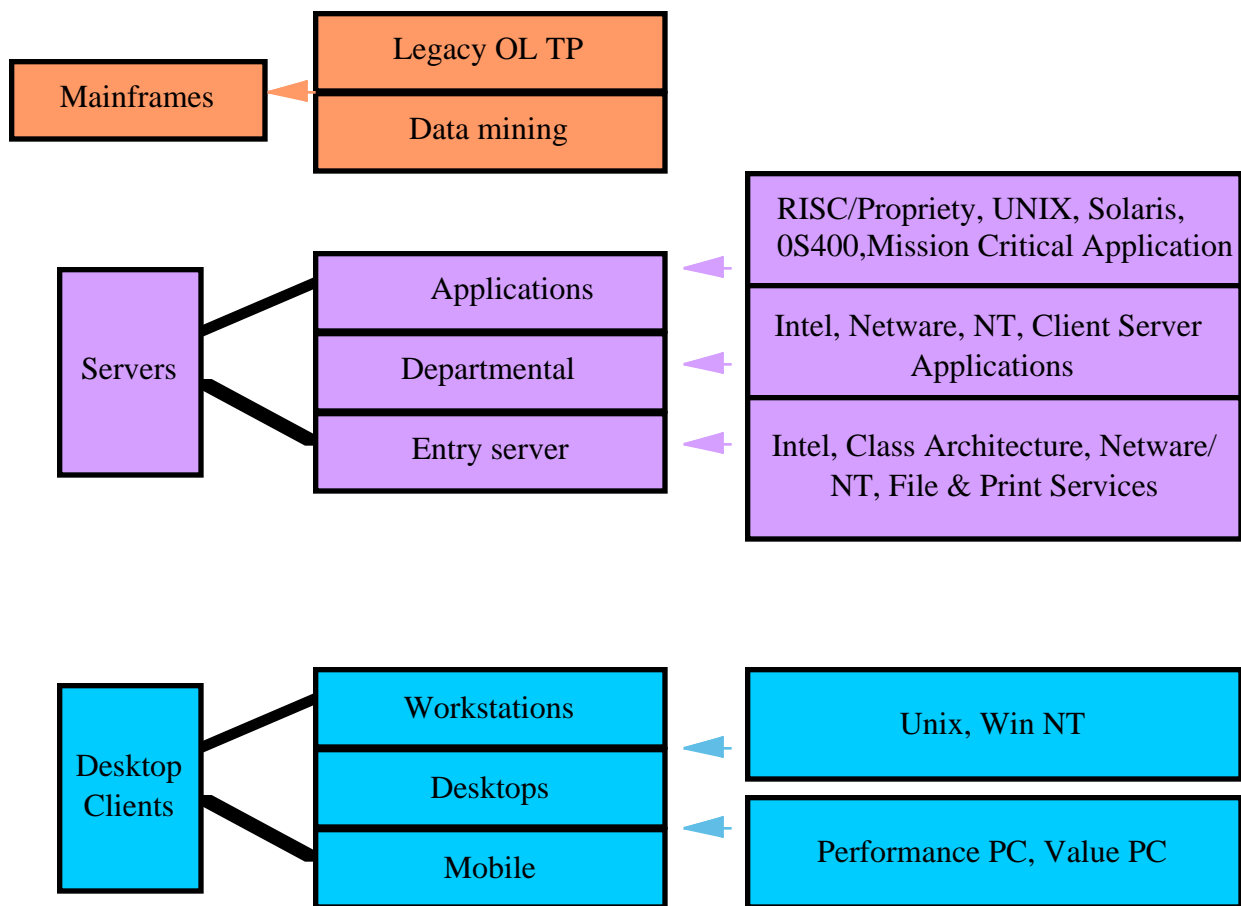

- Further segmentation
- Continuous pressure on cost

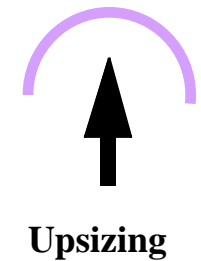

Tape Markets Today!

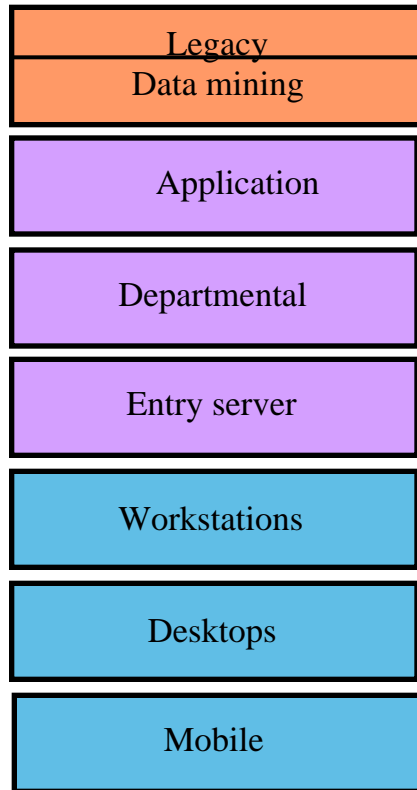
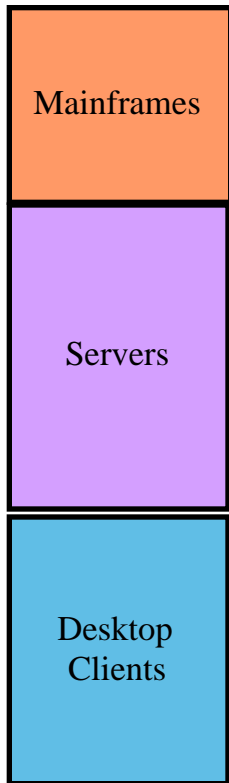

Standards

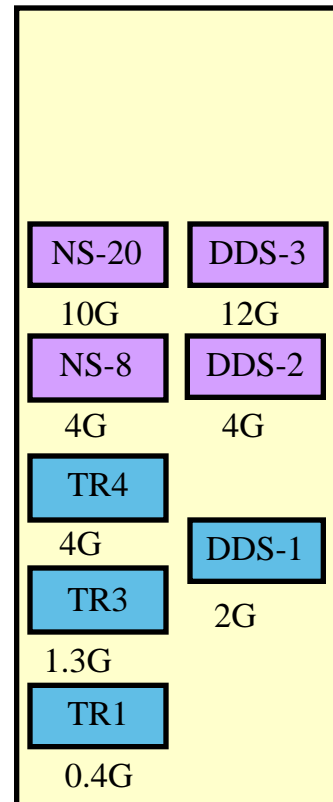

Proprietary

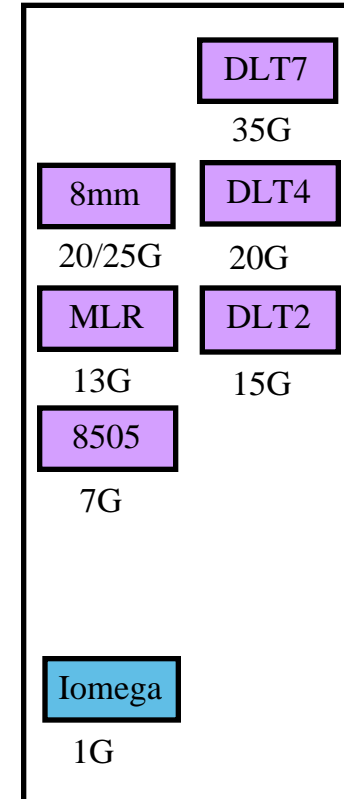



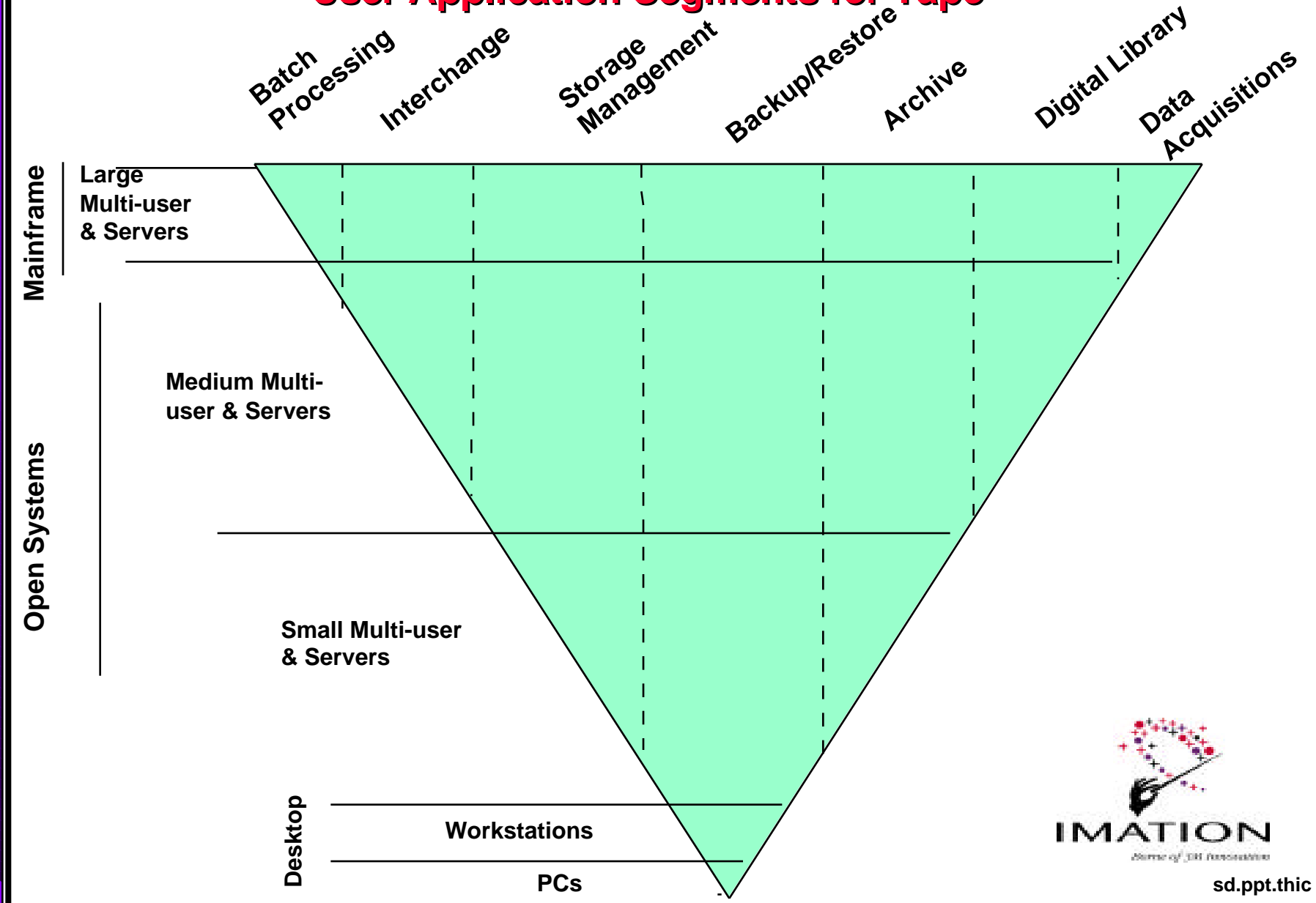



User Application Segments for Tape

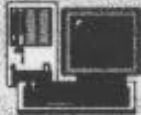

sd.ppt.thic

Source: Model from IBM & Imation

Tape Product Positioning

| Segment Name | Client | | | Server | | | |
|-------------------------|---|---|--|---|---|---|---|
| |  |  |  |  |  |  |  |
| | Value PC | High Performance PC, Workstation | UNIX Workstation | Small PC Server | Large PC Server | Midrange Server | Enterprise Server |
| Application | Home/Office Desktop | Home/Office Desktop | Business Workstation | Department/Application | Department/Application | Department | Database, Telecommunications |
| Systems (Typical) | Compaq Deskpro 2000-6000 | Compaq Pro WS 5000-8000 | SUN SparcStation | Compaq ProLiant 2500 | Compaq ProLiant 5000 | Compaq ProLiant 6000 HP 9000 | Tandem Himalaya, IBM System AS/400 |
| Processor | Intel/166 MHz | Intel II/Pro/166-233 MHz | RISC, Alpha/to 600 MHz | Intel/233 MHz | Intel; RAID | Intel, RISC, RAID | RISC, Proprietary |
| # Processors | 1 | 1-2 | — | 1 | 1-2 | 2-4 | — |
| Operating Environment | Windows 3.x, Windows 95 | Windows 95, Windows NT | UNIX, Windows NT | NetWare, Windows NT; 20 users | NetWare, Windows NT; 20-100 users | Windows NT, UNIX; 150-300 users | UNIX, OS/400 200+ users |
| Disc Capacity (Gbytes) | ≤3.2 | 3.2-8 | >8 | 4-9 | 9-36 | 9-50 | — |
| Price Range (\$000) | 1-2.5 | 2.5-4 | >3.5 | 3.5-10 | 10-40 | 40-200 | 100-500 |
| Primary Tape Solution | TR-3 | Travan 8 (TR-4) Travan NS8 | DDS-2, DDS-3 | Travan 8 (TR-4) Travan NS8 Travan NS20 | DDS-2, DDS-3 | AIT | — |
| Secondary Tape Solution | — | DDS-2 | Travan 8 (TR-4) Travan NS8 Travan NS20 | DDS-2, DDS-3 | AIT | DDS-3 | — |

IMATION

Member of 3M Association

sd.ppt.thic

At an annual CGR of 16%, the Entry Level Server market is one of the fastest growing market segments.

Application servers, or departmental servers, offer a different opportunity and an additional opportunity to data center system configuration



97% of business in America today have fewer than 100 employees

There are six million business in this category; 4.2 million are computerized with a median of 14 computers at each company

25% have multiple PCs, and are “Network” potentials



The evolving storage market is as big as, if not greater than, the existing market

- ◆ **Travan NS drives and media are
the cost effective solution to meet
this markets' backup need**



Travan NS 8 vs DDS 2

Product Features

| | | |
|------------------------|---------|---------|
| ◆ Read while write | Yes | Yes |
| ◆ Hardware Compression | Yes | Yes |
| ◆ Capacity | 8 GB | 8GB |
| ◆ Performance | 1.6MB/S | 1.8MB/S |
| ◆ Annual Field Failure | <2.5% | 11%* |

* reported by Statistical Research, Santa Clara, CA



Travan NS 20 vs DDS 3

Product Features

| | | |
|------------------------|--------|--------|
| ◆ Read while write | Yes | Yes |
| ◆ Hardware Compression | Yes | Yes |
| ◆ Capacity | 20 GB | 24GB |
| ◆ Performance | 2 MB/S | 2 MB/S |
| ◆ Annual Field Failure | <2.5% | 11%* |

* reported by Statistical Research, Santa Clara, CA

